

## Adapter-Satz für Bremsen-Entlüfter

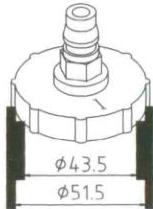

### ADAPTER

1



Ø 43,5 mm

Chrysler, Dodge Jeep, Plymouth

2

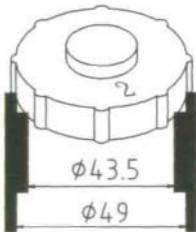

Ø 43,5 mm

Chrysler, Dodge, Jeep, Plymouth

3

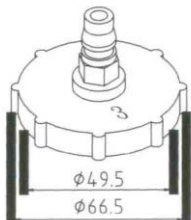

Ø 49,5 mm

GM, Buick, Cadillac, Chevrolet, GMC, Hummer,  
Oldsmobile, Pontiac, einige Mazda

4

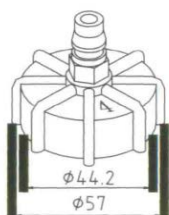



Ø 44,2 mm

BMW, Audi, EU-Fahrzeuge

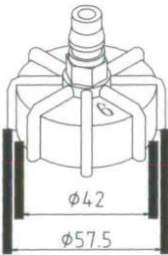
5   $\varnothing$  45 mm EU-Fahrzeuge

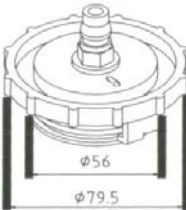
6   $\varnothing$  42 mm  
Euro-Adapter  
Alfa Romeo, Audi, BMW, Jaguar, Land Rover,  
Mercedes, Peugeot, Porsche, Renault, Saab, VW,  
Volvo, Chrysler Crossfire, Daewoo, Ford, KIA, einige  
Mazda und Mini

9   $\varnothing$  56 mm Honda

10   $\varnothing$  34,5 mm Nissan

**Universal-Adapter 7**

inkl. einem Druckstück, 2x Gewindebolzen, 2x Rändelmuttern und einer Kette.

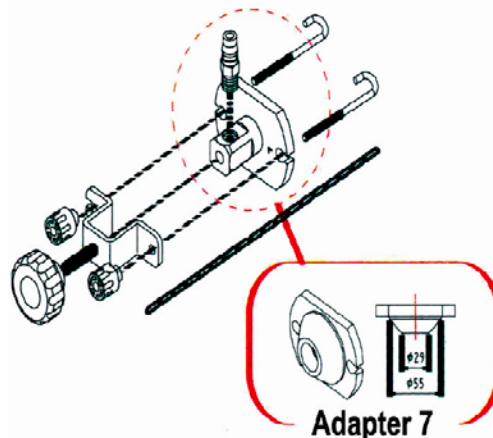

## Brake Bleeding Adaptor Set



### ADAPTOR

1

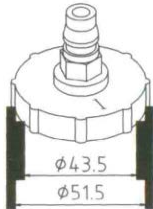

Ø 43.5 mm

Chrysler, Dodge Jeep, Plymouth

2

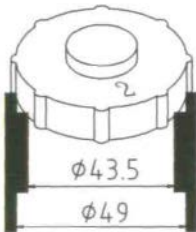

Ø 43.5 mm

Chrysler, Dodge, Jeep, Plymouth

3

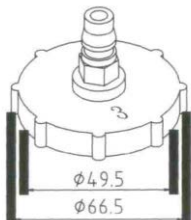

Ø 49.5 mm

GM, Buick, Cadillac, Chevrolet, GMC, Hummer,  
Oldsmobile, Pontiac, some Mazda models

4

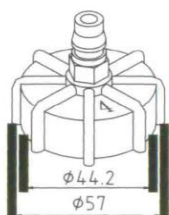



Ø 44.2 mm

BMW, Audi, european vehicles

5   $\varnothing$  45 mm European Vehicles

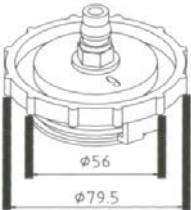
6   $\varnothing$  42 mm European Adaptor  
Alfa Romeo, Audi, BMW, Jaguar, Land Rover,  
Mercedes, Peugeot, Porsche, Renault, Saab, VW,  
Volvo, Chrysler Crossfire, Daewoo, Ford, KIA, some  
Mazda and Mini

9   $\varnothing$  56 mm Honda

10   $\varnothing$  34.5 mm Nissan

**Universal Adapter 7**

including a pressure plate, 2x studs, 2x collars and a chain.

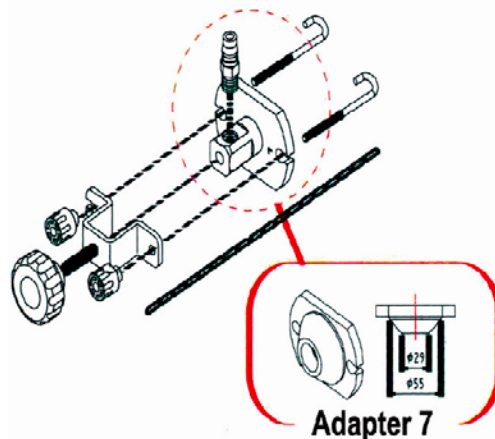

**Jeu d'adaptateurs pour purgeur de frein**



**ADAPTATEUR**

1

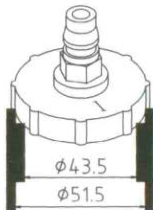

Ø 43,5 mm

Chrysler, Dodge Jeep, Plymouth

2

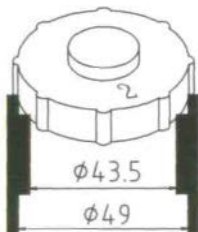

Ø 43,5 mm

Chrysler, Dodge, Jeep, Plymouth

3

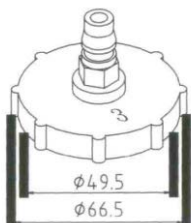

Ø 49,5 mm

GM, Buick, Cadillac, Chevrolet, GMC, Hummer, Oldsmobile, Pontiac, un peu de Mazda

4

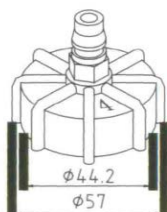

Ø 44,2 mm

BMW, Audi, Véhicules de l'UE



5  Ø 45 mm Véhicules de l'UE

6  Ø 42 mm Adaptateur euro  
Alfa Romeo, Audi, BMW, Jaguar, Land Rover,  
Mercedes, Peugeot, Porsche, Renault, Saab, VW,  
Volvo, Chrysler Crossfire, Daewoo, Ford, KIA, un peu  
de Mazda et Mini

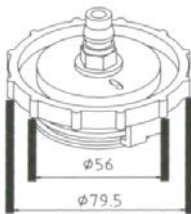
9  Ø 56 mm Honda

10  Ø 34,5 mm Nissan

**Adaptateur universel 7**

Y compris une pièce de pression, 2x boulons filetés, 2x écrous moletés et une chaîne.

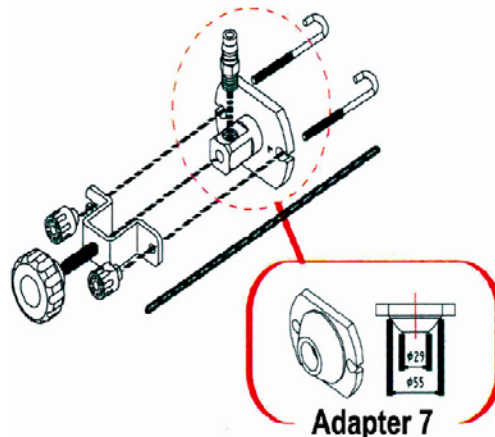

**Set di adattatori per spurgo freno**



**ADATTATORI**

1

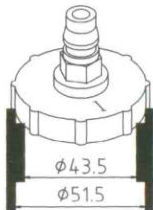

Ø 43.5 mm

Chrysler, Dodge Jeep, Plymouth

2

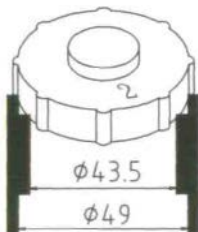

Ø 43.5 mm

Chrysler, Dodge, Jeep, Plymouth

3

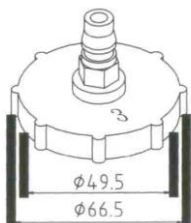

Ø 49.5 mm

GM, Buick, Cadillac, Chevrolet, GMC, Hummer,  
Oldsmobile, Pontiac, alcuni modelli Mazda

4

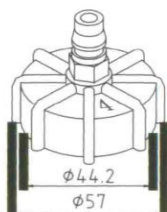

Ø 44.2 mm

BMW, Audi, Veicoli europei

5

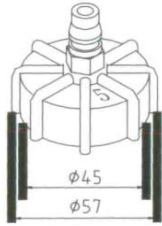

Ø 45 mm

Veicoli europei

6

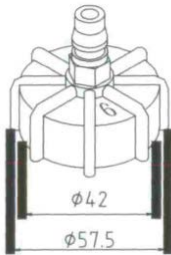

Ø 42 mm

Adattatore per l'Europa  
Alfa Romeo, Audi, BMW, Jaguar, Land Rover,  
Mercedes, Peugeot, Porsche, Renault, Saab, VW,  
Volvo, Chrysler Crossfire, Daewoo, Ford, KIA, alcuni  
modelli Mazda e Mini

9

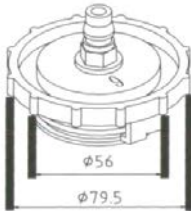

Ø 56 mm

Honda

10



Ø 34.5 mm

Nissan

### 7 Adattatori universali

Inclusa una piastra per la pressione, 2x chiodi, 2x fascette e una catena.

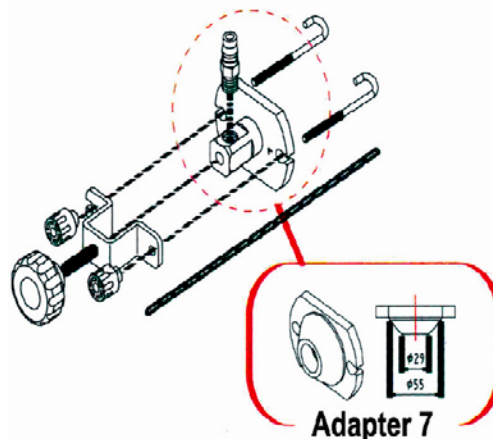



## Juego de adaptadores para frenos sangrantes



### ADAPTADORES

1

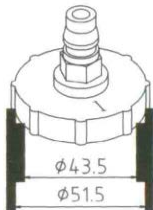

Ø 43,5 mm

Chrysler, Dodge Jeep, Plymouth

2

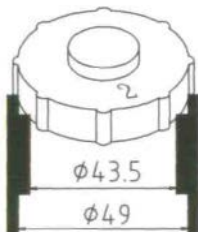

Ø 43,5 mm

Chrysler, Dodge, Jeep, Plymouth

3

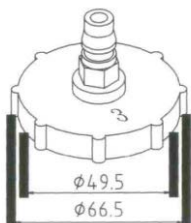

Ø 49,5 mm

GM, Buick, Cadillac, Chevrolet, GMC, Hummer, Oldsmobile, Pontiac, algunos modelos Mazda

4

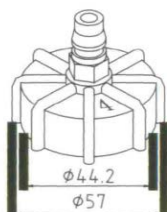

Ø 44,2 mm

BMW, Audi, Vehículos de la UE

5   $\varnothing$  45 mm Vehículos de la UE

$\varnothing$ 45  
 $\varnothing$ 57

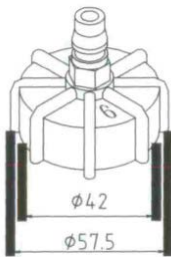
6   $\varnothing$  42 mm Adaptador euro  
Alfa Romeo, Audi, BMW, Jaguar, Land Rover,  
Mercedes, Peugeot, Porsche, Renault, Saab, VW,  
Volvo, Chrysler Crossfire, Daewoo, Ford, KIA, algunos  
modelos Mazda y Mini

$\varnothing$ 42  
 $\varnothing$ 57.5

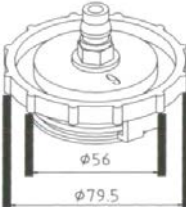
9   $\varnothing$  56 mm Honda

$\varnothing$ 56  
 $\varnothing$ 79.5

10   $\varnothing$  34,5 mm Nissan

$\varnothing$ 34.5  
 $\varnothing$ 53.5

**Adaptador universal 7**

Incluye una pieza de presión, 2 tornillos roscados, 2 tuercas moleteadas y una cadena.

